

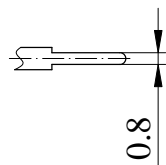

ISO 9001 國際品質認證
ISO 9001 CERTIFICATE

松暉電機工業股份有限公司
SONG HUEI ELECTRIC CO., LTD.
佛山市松暉電機科技有限公司
FOSHAN SONG HUEI ELECTRIC CO., LTD.

一般事項 General	
使用溫度範圍 Operating temperature	-10 °C ~ +70 °C
手工焊接 Manual soldering	300 °C max 3 sec
電氣特性 Electrical Characteristics	
總阻值 (R) Total resistance	1 KΩ ~ 2 MΩ
總阻值容許誤差 Total resistance tolerance	± 20 % (More than 1 MΩ ± 30 %)
阻值線性 Resistance taper	<input type="checkbox"/> A <input type="checkbox"/> B <input type="checkbox"/> C <input type="checkbox"/> D <input type="checkbox"/> W
摺動雜音 Sliding noise	Less than 100 mV
殘留阻值 Residual resistance	Less than 20 Ω
定格電力 Rated power (W)	Linear (B) taper: 0.1 W Other tapers: 0.05 W
額定電壓 Rated voltage (V)	$E = \sqrt{P * R}$ E: Rated voltage 額定電壓 (V) P: Power rating 額定電力 (W) R: Nominal total resistance 公稱全阻抗值 (Ω) 當額定電壓超過最高使用電壓的時候，最高使用電壓即為額定電壓。 When the rated voltage exceeds the maximum operating voltage, the maximum operating voltage shall be the rated voltage.
最高使用電壓 Max operating voltage	Linear (B) taper: AC 100 V Other tapers: AC 50 V
絕緣阻抗 Insulation resistance	More than 100 MΩ at DC 250 V
耐電壓 Withstand voltage	1 minute at AC 250 V
相互偏差 Gang error	-40 dB ~ 0 dB ≤ 3 dB
機械特性 Mechanical Characteristics	
全回轉角度 Total rotational angle	300 ° ± 5 °
全回扭力 Rotational torque	30 ~ 250 gf.cm
C.C 扭力 C.C torque	<input type="checkbox"/> 50 ~ 300 gf.cm
全回轉止強度 Rotational stopper strength	6 Kgf.cm max
軸推拉強度 Shaft push-pull strength	8 Kgf max
回轉壽命 Rotational life	15,000 cycles

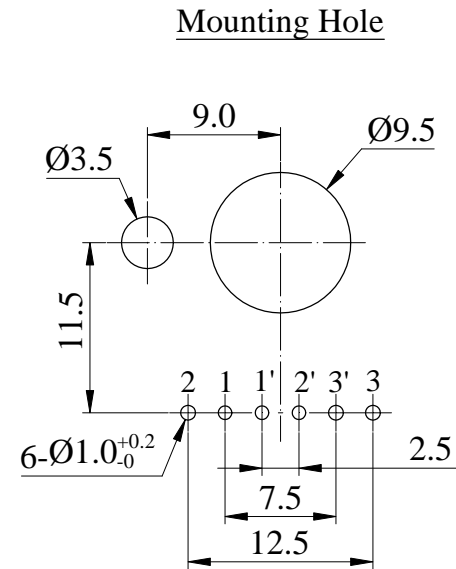
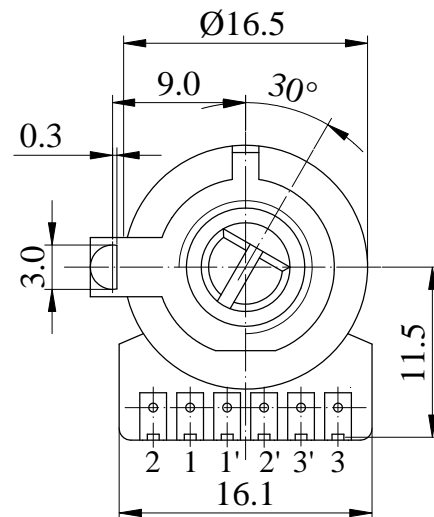
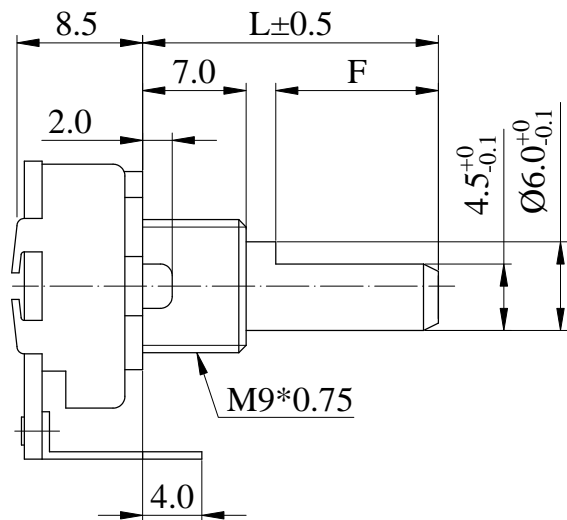

CIRCUIT

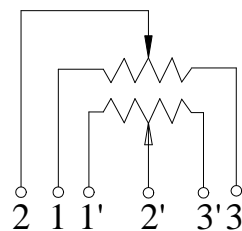

SHAFT SHOWN IN FULL C.C.W POSITION

Non notation tolerance

L=	15	20	25	30		< 10	±0.3
F=	8	12	12	12		10 ~ 100	±0.5
choose						> 100	±0.8



SONG HUEI ELECTRIC CO., LTD.
FOSHAN SONG HUEI ELECTRIC CO., LTD.

MODEL: R1611G(F)/PH

Approval



Checked



Projected



UNIT

mm

SCALE

2:1

VERSION

1.1

DATE

2011.08.17

DRAWING NO.

R-161G-001



ISSUE

图元整理

SUBJECT

何鴻根

NAME

2018.12.28

DATE

RECORD

Shaft Types 軸型:

KC Type (18 teeth)

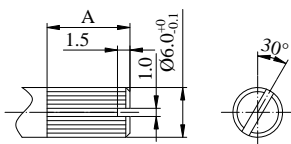

Horizontal with bushing

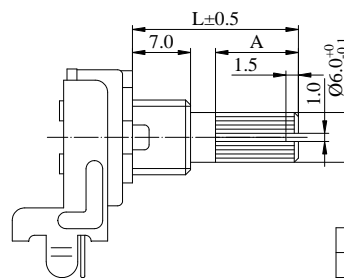

L	20	25	30
A	12	12	12

Horizontal

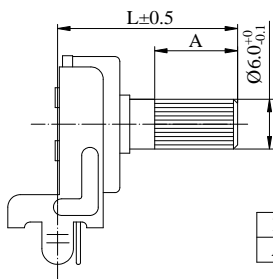

L	18.5	23.5	28.5	33.5
A	7	12	12	12

Vertical

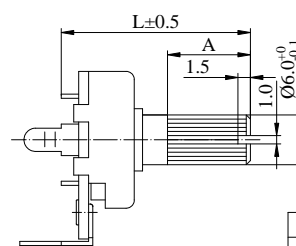

L	20	25	30
A	7	12	12

F Type

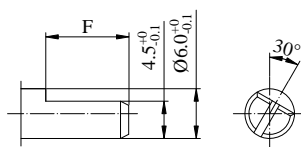

Horizontal

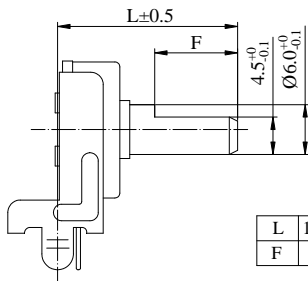

L	18.5	23.5	28.5	33.5
F	7	12	12	12

Horizontal with bushing

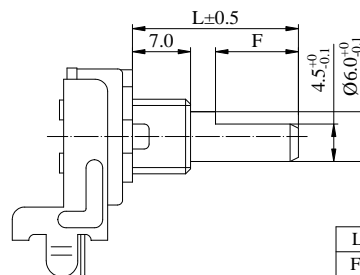

L	20	25	30
F	12	12	12

Vertical

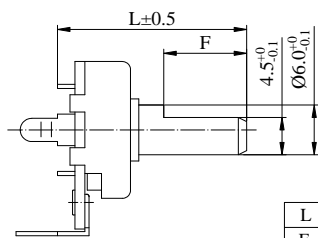

L	20	25	30
F	7	12	12

Vertical with bushing

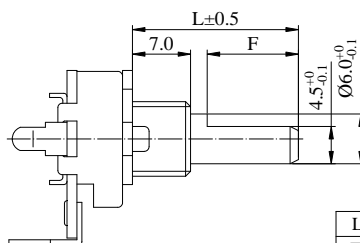

L	20	25	30
F	7	12	12

Bushing Dimension

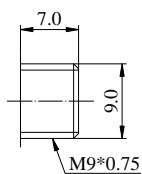

Stopper Dimension

