

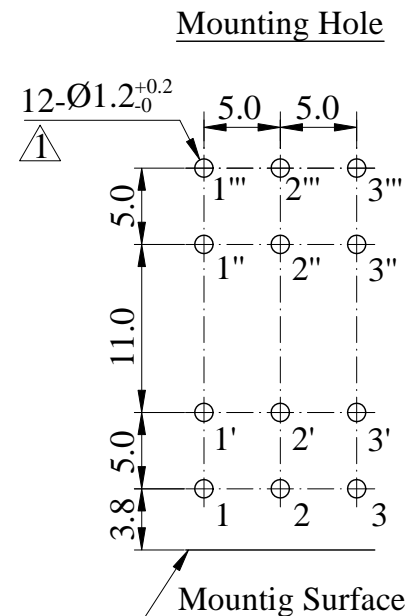

ISO 9001 國際品質認證
ISO 9001 CERTIFICATE

松暉電機工業股份有限公司
SONG HUEI ELECTRIC CO., LTD.
佛山市松暉電機科技有限公司
FOSHAN SONG HUEI ELECTRIC CO., LTD.

一般事項 General	
使用溫度範圍 Operating temperature	-10 °C ~ +70 °C
手工焊接 Manual soldering	300 °C max 3 sec
電氣特性 Electrical Characteristics	
總阻值 (R) Total resistance	500 Ω ~ 2 MΩ
總阻值容許誤差 Total resistance tolerance	± 20 % (More than 1 MΩ ± 30 %)
阻值線性 Resistance taper	<input type="checkbox"/> A <input type="checkbox"/> B <input type="checkbox"/> C <input type="checkbox"/> D <input type="checkbox"/> W <input type="checkbox"/> MN
摺動雜音 Sliding noise	Less than 47 mV (Taper 05 A / 05 C : 80 mV)
殘留阻值 Residual resistance	Less than 20 Ω
定格電力 Rated power (W)	Linear (B) taper: 0.125 W Other tapers: 0.06 W
額定電壓 Rated voltage (V)	$E = \sqrt{P * R}$ E: Rated voltage 額定電壓 (V) P: Power rating 額定電力 (W) R: Nominal total resistance 公稱全阻抗值 (Ω) 當額定電壓超過最高使用電壓的時候，最高使用電壓即為額定電壓。 When the rated voltage exceeds the maximum operating voltage,the maximum operating voltage shall be the rated voltage.
最高使用電壓 Max operating voltage	Linear (B) taper: AC 200 V Other tapers: AC 150 V
絕緣阻抗 Insulation resistance	More than 100 MΩ at DC 500 V
耐電壓 Withstand voltage	1 minute at AC 500 V
相互偏差 Gang error	-40 dB ~ 0 dB ≤ 3 dB
機械特性 Mechanical Characteristics	
全回轉角度 Total rotational angle	300 ° ± 5 °
全回扭力 Rotational torque	30 ~ 200 gf.cm
C.C 扭力 C.C torque	<input type="checkbox"/> 100 ~ 350 gf.cm
全回轉止強度 Rotational stopper strength	6 Kgf.cm max
軸推拉強度 Shaft push-pull strength	7 Kgf max
回轉壽命 Rotational life	15,000 cycles

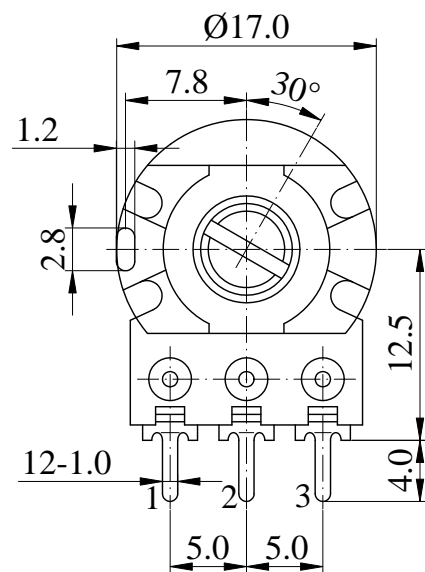
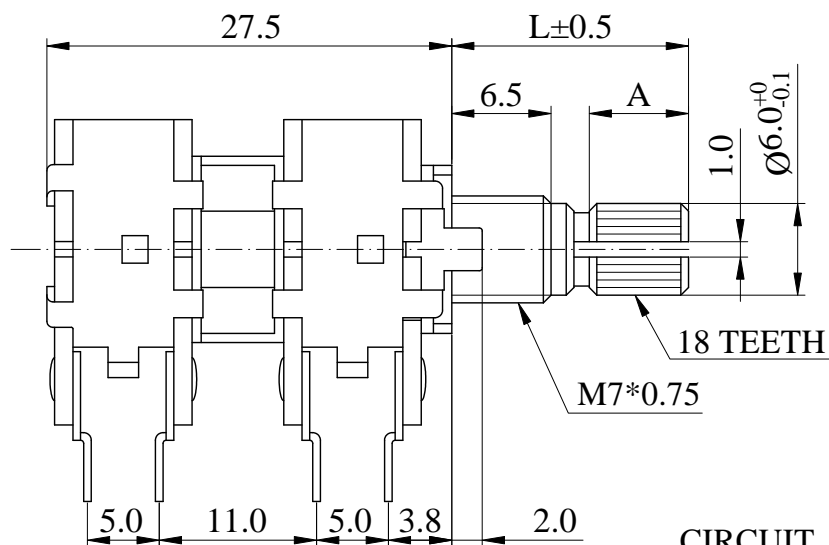

CIRCUIT

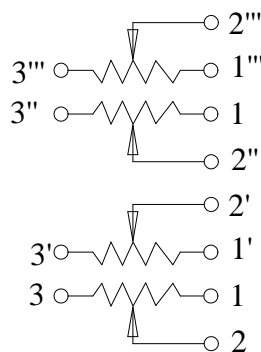

SHAFT SHOWN IN FULL C.C.W POSITION

						Non notation tolerance	
L=	15	20	25	30		< 10	±0.3
A=	6	10	12	12		10 ~ 100	±0.5
choose						> 100	±0.8



SONG HUEI ELECTRIC CO., LTD.
FOSHAN SONG HUEI ELECTRIC CO., LTD.

MODEL: RTT16(KC)/LAL

Approval



Checked



Projected



UNIT	mm	SCALE	2:1
VERSION	1.2	DATE	2012.05.17
DRAWING NO.	16T-048		

④			
③			
②	图元整理	何鸿根	2018. 12. 27
①	增加公差 ^{+0.2} ₋₀	邝俊华	2016. 03. 03
ISSUE	SUBJECT	NAME	DATE

RECORD

Shaft Types 軸型:

KC-Type

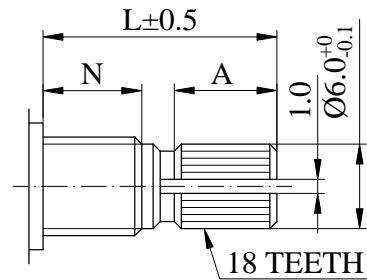

R-Type

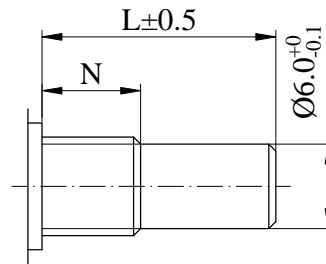

RE-Type

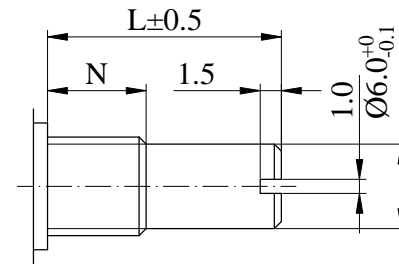

F-Type

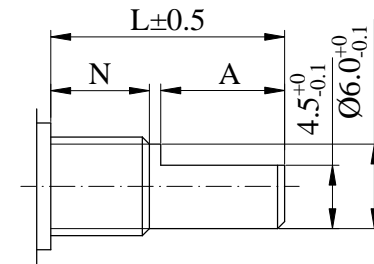

N=6.5mm									
Shaft Type	L	10	15	17	20	25	30	35	40
KC	A	2.2	6	6	10	12	12	12	12
	M	0.5	1	1	2	2	4	4	4
F	F	2.5	7	7	12	12	12	12	12
R,RE	L	10	15	17	20	25	30	35	40