



ISO 9001 國際品質認證
ISO 9001 CERTIFICATE

松暉電機工業股份有限公司
SONG HUEI ELECTRIC CO., LTD.
佛山市松暉電機科技有限公司
FOSHAN SONG HUEI ELECTRIC CO., LTD.

一般事項 General

使用溫度範圍 Operating temperature	-30 °C ~ 100 °C
手工焊接 Manual soldering	260 °C ± 10 °C max 2 sec

電氣特性 Electrical Characteristics

總阻值 (R) Total resistance	100 Ω ~ 2 MΩ
總阻值容許誤差 Total resistance tolerance	± 20 % (Resistance value ≤ 100 Ω and ≥ 1 MΩ: ± 30 %)
阻值線性 Resistance taper	B
殘留阻值 Residual resistance	R ≤ 500 Ω: Less than 20 Ω R > 500 Ω: Less than 2 % of total resistance value

定格電力 Rated power (W)	<p>對於抵抗體全域,連續能載荷之電力的最大值为 0.5 W,但是周圍溫度超過 70 °C 時,依下圖以減之 Rated power: 0.5 W, but when environment temperature is over 70 °C, please refer to below diagram.</p>
-------------------------	---

額定電壓 Rated voltage (V)	$E = \sqrt{P * R}$ E: Rated voltage 額定電壓 (V) P: Power rating 額定電力 (W) R: Nominal total resistance 公稱全阻抗值 (Ω) 當額定電壓超過最高使用電壓的時候,最高使用電壓即為額定電壓。 When the rated voltage exceeds the maximum operating voltage,the maximum operating voltage shall be the rated voltage.
---------------------------	---

最高使用電壓 Max operating voltage	DC 250 V
---------------------------------	----------

機械特性 Mechanical Characteristics

全回轉角度 Total rotational angle	270 ° ± 15 °
回轉力矩 Rotational torque	50 ~ 350 gf.cm
回轉止強度 Rotational stopper strength	0.8 Kgf.cm max

耐候性 Weather Performance

項目 Item	測試條件 Test Conditions	規格 Performance
溫度特性 Temperature characteristics	無負荷時,在 70 °C ± 3 °C 之槽內,放置 5 小時後。 5 hours without load and in temperature 70 °C ± 3 °C。	抵抗值的變化為 ± 5 % 以內。 The change of resistance value is within ± 5 % 。
溫度回圈 Temperature cycles	無負荷 -30 °C (30 分) → 常溫常濕 (15 分) → 100 °C (30 分) → 常溫常濕 (15 分) 迴圈放置,重複做 5 次迴圈後,在常溫常濕之室內,以無負荷放置 2 小時以上。 Without load and after rotation, putting under temperature -30 °C (30 mins) → Room temperature / humidity (15 mins) → 100 °C (30 mins) → Room temperature / humidity (15 mins). Repeating for 5 times, place under room temperature and humidity without load for 2 hours。	抵抗值的變化為 ± 5 % 以內。 The change of resistance value is within ± 5 % 。



ISO 9001 國際品質認證
ISO 9001 CERTIFICATE

松暉電機工業股份有限公司
SONG HUEI ELECTRIC CO., LTD.
佛山市松暉電機科技有限公司
FOSHAN SONG HUEI ELECTRIC CO., LTD.

長時間耐熱性 Long time heat test	無負荷時，100 °C ± 3 °C 之槽內，放置 1000 ± 12 小時後，以無負荷放置在常溫常濕之室內 2 小時以上。 Without load, place under 100 °C ± 3 °C for 1000 ± 12 hours, then further without load place under room temperature / humidity for 2 hours.	抵抗值的變化為 ± 5 % 以內。 The change of resistance value is within ± 5 % .
耐濕特性 Humidity characteristics	以無負荷在 40 °C ± 2 °C，濕度 90 ~ 95 % 之槽內，放置 1000 ± 12 小時後，以無負荷放置在常溫常濕之室內 5 小時以上。 Without load, place under temperature 40 °C ± 2 °C and humidity 90 ~ 95% for 1000 ± 12 hours, then further without load place under room temperature / humidity for 5 hours.	抵抗值的變化為 ± 5 % 以內。 The change of resistance value is within ± 5 % .
焊錫耐熱性 Soldering head test	在 260 °C ± 10 °C 之焊錫槽，將端子之前端（由端子 1.5 ~ 2.0 mm）浸漬 3 ± 0.5 秒後在常溫常濕之室內，以無負荷放置 1 小時以上。 The top of the terminal shall be dipped 1.5 ~ 2.0 mm in the solder bath of 260 °C ± 10 °C for 3 ± 0.5 seconds, then place under room temperature / humidity without load for 1 hours.	抵抗值的變化為 ± 2 % 以內。 The change of resistance value is within ± 2 % .
耐久特性 Durability		
項目 Item	測試條件 Test Conditions	規格 Performance
回轉壽命特性 Life test	無負荷時，將摺動片以 6 秒一次來回之速度，有效回轉角度在 90 % 以上回轉 50 ± 2 次。 50 ± 2 cycles of more than 90 % total rotation angle operation shall be performed continuously at the rate of 6 cycles/minute without load.	抵抗值的變化為 ± 10 % 以內。 The change of resistance value is within ± 10 % .
負荷壽命特性 Life load	在 70 °C ± 3 °C 之溫度槽內，加上 1.5 小時工作電壓後，再關閉 0.5 小時，如此迴圈連續重複做 1000 ± 12 小時，在常溫常濕之室內，以無負荷放置在常溫常濕之室內 5 小時以上。 Place under temperature 70 °C ± 3 °C, and apply working voltage for 1.5 hours, then stop for 0.5 hours, reaping above for 1000 ± 12 hours. After it, place under room temperature / humidity without load for 5 hours.	抵抗值的變化為 ± 5 % 以內。 The change of resistance value is within ± 5 % .
耐濕負荷壽命 Humidity load life	在 40 °C ± 2 °C，濕度 90 ~ 95 % 之槽內，加上 1.5 小時工作電壓後，再關閉 0.5 小時，如此迴圈連續重複做 1000 ± 12 小時，在常溫常濕之室內，以無負荷放置在常溫常濕之室內 5 小時以上。 Place under temperature 40 °C ± 2 °C & humidity 90 ~ 95 %, and apply working voltage for 1.5 hours, then stop for 0.5 hours, reaping above for 1000 ± 12 hours. After it, place under room temperature / humidity without load for 5 hours.	抵抗值的變化為 ± 5 % 以內。 The change of resistance value is within ± 5 % .
溫度係數 Temperature coefficient	以無載荷 25 °C (30 分) → -30 °C (30 分) → 25 °C (30 分) → 100 °C (30 分) 放置時之溫度係數是 ± 250 ppm / °C 以內。 Without load, putting under temperature 25 °C (30 mins) → -30 °C (30 mins) → 25 °C (30 mins) → 100 °C (30 mins), the temperature coefficient is within ± 250 ppm / °C .	

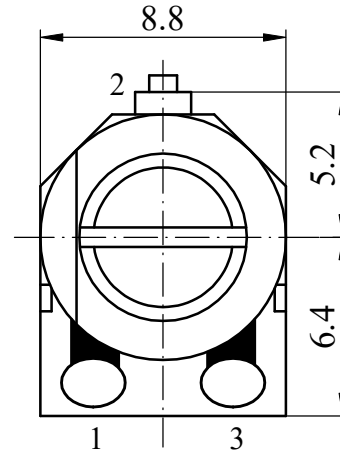
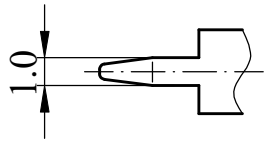
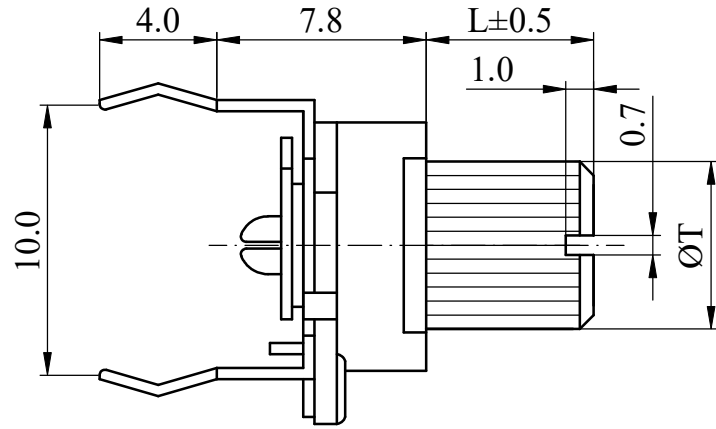
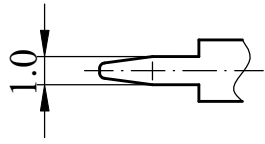

Mounting Hole

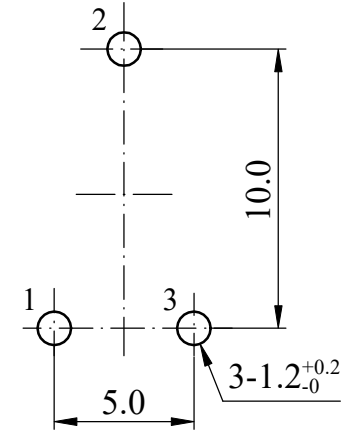

CIRCUIT

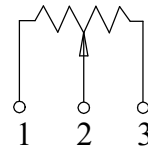

	H	P	X	Z	Non notation tolerance	
L	6	10	12	15	< 10	±0.3
ØT	6	6	5	6	10 ~ 100	±0.5
choose					> 100	±0.8

S® SONG HUEI ELECTRIC CO., LTD.
FOSHAN SONG HUEI ELECTRIC CO., LTD.

MODEL: TK805M□/0085

△				
△				
△				
△	TK805MP,L=9.5改为10	何鸿根	2022.07.25	
ISSUE	SUBJECT	NAME	DATE	
RECORD				

Approval



Checked



Drawn



UNIT

mm

SCALE

4:1

VERSION

1.1

DATE

2021.01.04

DRAWING NO.

SH-8Ø-023

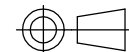

RECORD